

TB8100 base station

Calibration Kit User's Manual



MBA-00011-07
Issue 7
April 2006

Contact Information

Tait Radio Communications Corporate Head Office

Tait Electronics Limited
P.O. Box 1645
Christchurch
New Zealand

For the address and telephone number of regional offices, refer to the TaitWorld website:

Website: <http://www.taitworld.com>

Technical Support

For assistance with specific technical issues, contact Technical Support:

E-mail: support@taitworld.com

Website: <http://support.taitworld.com>

Copyright and Trademarks

All information contained in this manual is the property of Tait Electronics Limited. All rights reserved.

This manual may not, in whole or in part, be copied, photocopied, reproduced, translated, stored, or reduced to any electronic medium or machine-readable form, without prior written permission from Tait Electronics Limited.

The word TAIT and the TAIT logo are trademarks of Tait Electronics Limited.

All trade names referenced are the service mark, trademark or registered trademark of the respective manufacturers.

Disclaimer

There are no warranties extended or granted by this manual. Tait Electronics Limited accepts no responsibility for damage arising from use of the information contained in the manual or of the equipment and software it describes. It is the responsibility of the user to ensure that use of such information, equipment and software complies with the laws, rules and regulations of the applicable jurisdictions.

Enquiries and Comments

If you have any enquiries regarding this manual, or any comments, suggestions and notifications of errors, please contact Technical Support.

Updates of Manual and Equipment

In the interests of improving the performance, reliability or servicing of the equipment, Tait Electronics Limited reserves the right to update the equipment or this manual or both without prior notice.

Intellectual Property Rights

This product may be protected by one or more patents of Tait Electronics Limited together with their international equivalents, pending patent applications and registered trade marks: NZ338097, NZ508054, NZ508340, NZ508806, NZ508807, NZ509242, NZ509640, NZ509959, NZ510496, NZ511155, NZ511421, NZ516280/519742, NZ519118, NZ519344, NZ520650/537902, NZ521450, NZ524509, NZ524537, NZ524630, NZ530819, NZ534475, NZ534692, NZ535471, NZ536945, NZ537434, NZ534369, NZ522236, NZ524378, AU2003281447, AU2002235062, AU2004216984, CA2439018, EU03784706.8, EU02701829.0, EU04714053.8, GB23865476, GB2386010, GB0516094.0, GB0516092.4, US09/847322, US60/613748, US60/539617, US10/520827, US10/468740, US5,745,840, US10/520827.

To our European Customers



Tait Electronics Limited is an environmentally responsible company which supports waste minimization and material recovery. The European Union's Waste Electrical and Electronic Equipment

Directive requires that this product be disposed of separately from the general waste stream when its service life is over. Please be environmentally responsible and dispose through the original supplier, your local municipal waste "separate collection" service, or contact Tait Electronics Limited.

Contents

Preface	iii
Typographical Conventions	iii
Associated Documentation	iii
Publication Record	iii
Basic Tasks	1
Using the TB8100 Calibration Kit	1
About the Toolbar	2
About the Status Bar	2
Equipment Required	3
Calibration Overview	3
Field Calibration	4
Service Center Calibration	4
Selecting the Communications Port	5
Connecting to a Reciter Outside the Subrack	5
Connecting to a Reciter via the Control Panel	7
Disconnecting from the Base Station/Reciter	7
Troubleshooting	8
Adjusting the Frequency Setup	9
Adjusting the Receiver Lock Band	9
Tuning a UHF Receiver Front End	10
Tuning a VHF Receiver Front End	12
Adjusting the Exciter Lock Band	14
Selecting the Exciter Sub-band	15
Calibrating the Reciter	16
Calibrating the Exciter	16
Automatically Tune the Frequency Control Loop (FCL)	16
Calibrating the FCL	16
Calibrating the VCO	18
Calibrating the RSSI	19
Audio Calibration	20
Calibrating the Balanced Lines	20
Calibrating the Unbalanced Lines	21
Carrier Frequency Offset Adjustment (Older Reciters)	23
Carrier Frequency Offset Adjustment (Newer Reciters)	24
Calibrating the Power Amplifier	27
Calibrating the PA Bias	27
Calibrating the Forward and Reverse Detector Bias Voltages	27
Calibrating the PA Power	28
Troubleshooting Tips	29

Calibrating the Power Management Unit 30
 Calibrating the PMU Output Voltage 30

Index 34

Preface

Welcome to the TB8100 Calibration Kit User's Manual. This manual provides you with information about the Tait TB8100 Calibration Kit in PDF format. You can view it online or print it if you want a paper copy. It describes how to use Version 03.00 of the Calibration Kit.

Typographical Conventions

'File > Exit' means 'click File on the menu bar, then select Exit'.

Associated Documentation

- *Online Help*. The Calibration Kit also has online Help. It contains more or less the same information as this manual. To view it, start the Calibration Kit, then press F1 or click the Help icon on the toolbar. If you are in a dialog box, click the Help button.
- *TBA0STU/TBA0STP CTU Operation Manual*. This manual (MBA-00013-xx) provides detailed information about the Calibration and Test Unit.
- *TB8100 Installation and Operation Manual* (MBA-00005-xx).
- *TB8100 Service Manual* (service centers only). A glossary of terms is available in this manual (MBA-00016-xx).

For additional items, see the TB8100 Installation and Operation Manual and the TB8100 Service Kit User's Manual or online Help.

Publication Record

Version	Date	Description
1.0	June 2003	First release of the manual for Version 1.0.0 of the Tait TB8100 Calibration Kit software.
02.00	March 2004	Minor quality issues resolved and software changes documented for Version 02.00.
02.01 (MBA-00011-03)	September 2004	Carrier Frequency Offset Adjustment procedure for reciter version 00.03+ added. PA store supply voltage and PMU output voltage calibration added.
02.02 (MBA-00011-04)	December 2004	Changes for K-band reciters.
02.05 (MBA-00011-05)	March 2005	Minor changes for Calibration Kit software version 02.05. L-band reciters.
02.07 (MBA-00011-06)	June 2005	Separate sections for UHF and VHF receiver front end tuning. Selecting Exciter sub-band for exciters with two VCOs
03.00 (MBA-00011-07)	April 2006	Murata tuning tool now not used for UHF (H-band and K-band) receiver front end, as a different helical filter is fitted.

Basic Tasks

The TB8100 Calibration Kit is a Windows-based software program that allows you to adjust the switching ranges of Tait TB8100 base stations (both receiver and transmitter), and to flatten the receiver response across that switching range.

The TB8100 Calibration Kit is also used to calibrate the reciter, the PA, and the PMU after servicing.

Using the TB8100 Calibration Kit

When you start the TB8100 Calibration Kit, the main program window appears.

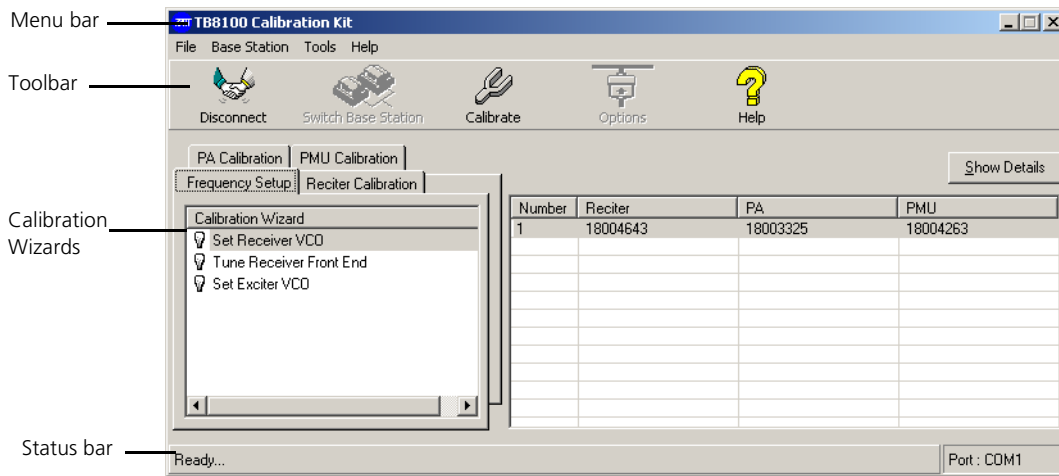

The main program window has four tabs. The Calibration Wizards displayed on each tab are only visible once you are connected to the reciter or the base station.

When the TB8100 Calibration Kit is connected to the reciter or base station, you can view further details (such as module number, type, serial number, band, and hardware version) about the currently selected module by clicking **Show Details**.

- Frequency Setup tab Shows the three Calibration Wizards that take you step-by-step through the frequency setup.
- Reciter Calibration tab Shows the seven calibration procedures that you can perform on the reciter. The Calibration Wizard takes you step-by-step through the procedure you have selected.
- PA Calibration tab Shows the four calibration procedures that you can perform on the power amplifier. The Calibration Wizard takes you step-by-step through the procedure you have selected.
- PMU Calibration tab Shows the procedure that you can perform on the PMU.

About the Toolbar

The toolbar gives you quick access to commonly used menu commands. For example, instead of selecting Base Station > Calibrate, you can click the Calibrate icon on the toolbar.



Connect	Connects the TB8100 Calibration Kit to the base station and opens the communication channels.
Switch Base Station	Lets you select another base station to calibrate if there are multiple base stations in the rack (not currently supported).
Calibrate	Runs the Calibration Wizard for the currently selected task.
Options	Allows you to set the COM port and default calibration mode.
Help	Opens the online help for the window you are currently in.

About the Status Bar

The status bar provides you with useful information that supplements the display in the main window.



Equipment Required

You need the following equipment for field calibration:

- Calibration and Test Unit (CTU, order code TBA0STU), which comes complete with the cables you will need for connection to the reciter/PA and the PC. For more information about the CTU, please refer to *TN-778 The Calibration and Test Unit*.
- Tool kit (order code TBA0ST2) which comprises tuning tools and the required screwdrivers in a tool pouch. The ceramic-tipped Murata tuning tool is used for most procedures, but the metal-tipped Johanson 8777 tuning tool with its narrower blade is needed for tuning the front end of H-band and K-band receivers.
- 10-30 V DC power supply (if the PMU does not have a 12 V or 24 V auxiliary power supply module)
- RS-232 cable
- RF attenuator (optional – depends on the setup)

You may need the following additional equipment for a service center calibration:

- Frequency counter
- Modulation meter
- RF signal source
- AC millivoltmeter (one with a differential input may be required for [“Calibrating the Balanced Lines” on page 20](#))

Refer to the individual procedures for equipment setup diagrams.

Calibration Overview

Any calibration process creates digital values and a calibration date, which are stored in the base station. The Service Kit can display the date of the last calibration. Many calibration procedures initially clear the stored digital values. If you do not complete the procedure or the stored digital values are outside acceptable limits, the module is left uncalibrated. An uncalibrated reciter will go into Download mode on startup and cannot be put into Run mode. An uncalibrated PA generates a calibration invalid alarm.

If the procedure you are performing requires access to tuning holes, you need to remove the reciter from the subrack and connect to it via the CTU.

The following tables summarise, for each procedure, whether or not you need to remove the reciter from the subrack, and what equipment (in addition to a PC with the TB8100 Calibration Kit software) you will need.

Field Calibration

The following procedures can be carried out in the field.

Procedure	Connection	Equipment Required
Adjusting receiver lock band	Outside subrack	Murata tuning tool, CTU
Tuning the receiver	Outside subrack	Murata tuning tool, Johanson tuning tool (for H-band and K-band reciters), CTU
Adjusting exciter lock band	Outside subrack	Murata tuning tool, CTU
Adjusting the carrier frequency offset	Depends on reciter	Murata tuning tool, Frequency counter, RF attenuator (only if using PA)

Service Center Calibration

The following additional procedures may need to be carried out after a module has been serviced.



Note: Replacing or repairing a board module may mean that the module's product code, product type (frequency band), serial number, and/or hardware version need to be re-entered or altered.

To do this, your Calibration Kit needs a dongle. The Service Manual indicates when a module detail needs re-entering or altering.

Reciter

Procedure	Connection	Equipment Required
Automatically tuning FCL	Inside subrack	None
Calibrating the FCL modulation	Outside subrack	Murata tuning tool, CTU, modulation meter, RF attenuator (only if using PA)
Calibrating the VCO modulation	Outside subrack	Murata tuning tool, CTU, modulation meter, RF attenuator (only if using PA)
Calibrating the RSSI	Inside subrack	RF signal source
Calibrating the balanced lines	Inside subrack	CTU, AC millivoltmeter (perhaps with differential input)
Calibrating the unbalanced lines	Inside subrack	CTU, AC millivoltmeter

Power Amplifier

Procedure	Connection	Equipment Required
Calibrating the PA bias	Inside subrack	None required
Calibrating the forward & reverse detector bias voltages	Inside subrack	None required
Calibrating the PA power	Inside subrack	None required

Power Management Unit

Procedure	Connection	Equipment Required
Output voltage calibration	Inside subrack	Digital multimeter

Selecting the Communications Port

Before you connect to a base station, you should first define the communications (COM) port that you want to use.

To select the COM port

1. Select Tools > Options.

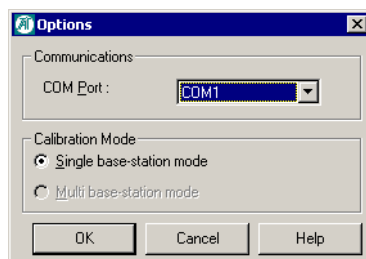

2. Select the port that you want to use from the COM Port list.



Note: The available COM ports are detected by the program and appear in the list.

3. Click **OK**.

The COM port you selected is now shown on the status bar.

Connecting to a Reciter Outside the Subrack

Field calibration procedures require access to the tuning holes, so you need to remove the reciter from the subrack and connect to it using a CTU.

Equipment

- Calibration and test unit (CTU)
- An IBM compatible PC
- 10-30 V DC power supply
- 16-way cable
- RS-232 cable

Setup

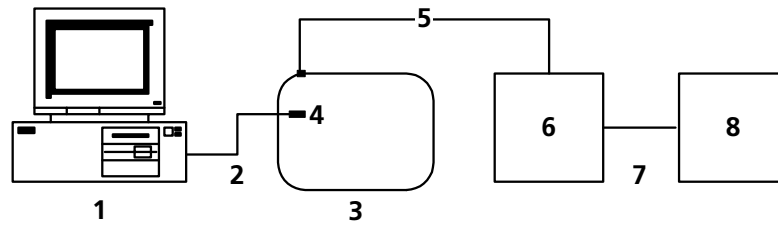

- | | | | |
|---|------------------|---|-------------------------|
| 1 | PC | 5 | 16-way cable |
| 2 | RS-232 cable | 6 | Reciter |
| 3 | CTU | 7 | Power cable |
| 4 | Programming port | 8 | 10-30 V DC power supply |

To connect to the reciter

1. Remove the reciter from the subrack (for instructions, see the Installation and Operation Manual).
2. Set up the equipment as follows.
 - Connect the reciter to the calibration and test unit (CTU) using the 16-way cable.
 - Connect your computer to the CTU by plugging the RS-232 cable into the programming port.
 - Using the power cable supplied in the calibration test kit, connect the reciter to the 10-30 V DC power supply, but do not power it up yet. If the base station's PMU has a 12 V or 24 V auxiliary power output, you can use this as the power supply. A connector is supplied with the CTU.
3. Start the TB8100 Calibration Kit program, and check that the [correct COM port is selected](#).
4. Click **Connect** to start the connection process.
5. When you see the "Waiting for logon prompt from Reciter" screen, power up the reciter. If it is already on, turn it off, and then on.



6. When the TB8100 Calibration Kit program has successfully connected to the reciter, the Calibration Wizards are displayed in the main window.

You are now ready to tune and calibrate the reciter.

Connecting to a Reciter via the Control Panel

For calibration procedures that do not require access to tuning holes, you can leave the reciter in the subrack and connect your PC to the control panel as follows.

Equipment

- An IBM compatible PC
- RS-232 cable

Setup

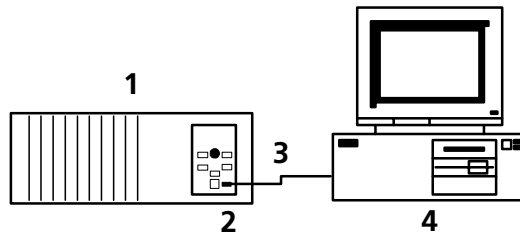

- | | | | |
|---|--------------|---|--------------|
| 1 | Base station | 3 | RS-232 cable |
| 2 | Serial port | 4 | PC |

To connect to a reciter in the subrack

1. Connect your computer to the base station by plugging the RS-232 cable into the serial port of the base station's control panel.



Note: If the base station is fitted with a TaitNet RS232 system interface, the control panel serial port is disabled; connect to the serial port at the reciter rear instead.

2. Start the TB8100 Calibration Kit program, and check that the [correct COM port is selected](#).
3. Click **Connect** to start the connection process.
4. As soon as you see the "Waiting for logon prompt from Reciter" screen, power up the base station. If it is already on, turn it off, and then on.

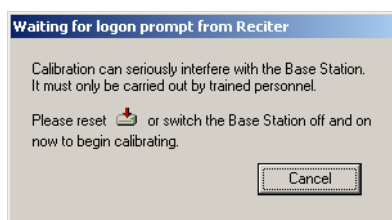

5. When the TB8100 Calibration Kit program has successfully connected to the base station, the Calibration Wizards are displayed in the main window. You are now ready to carry out calibration procedures.

Disconnecting from the Base Station/Reciter

Once calibration is completed, click **Disconnect** before exiting the Calibration Kit.



Important: Disconnecting when a calibration process is not completed may leave the base station in an uncalibrated state.

Troubleshooting

Application Errors All application errors are recorded in a log file called “CalError.log”. The data, time, location, and any other useful information is stored in this file, which may be helpful when troubleshooting.

The file is saved in the Logfiles subfolder of the application folder and stores up to 1000 of the most recent logged items.

Verifying the Software Version If you need to verify the version of the TB8100 Calibration Kit, select Help > About.

Commands Record All the commands sent and received by TB8100 Calibration Kit are saved in a file called “CCTM.log”. The date, time, command number, and parameters are all stored in this file, which may be helpful when troubleshooting.

The file is also saved in the Logfiles subfolder and stores up to 1000 of the most recent logged items.

Adjusting the Frequency Setup

Before the TB8100 base station is installed, connected, and configured, you must prepare it for operation by adjusting the switching range of the receiver, optimising the receiver response across the switching range, and adjusting the exciter lock band or selecting an exciter sub-band.



Note: If the required switching range for the base station has already been defined, you don't need to perform these procedures.



Tip: Use the TB8100 Service Kit to monitor the base station and find out its current switching range.



Important: Be careful when using the tuning tools. Applying too much pressure or attempting to turn the tool beyond the end of the range can crack the tuning slug. Unscrewing a slug too far can remove it completely.

Adjusting the Receiver Lock Band

The first step in preparing the TB8100 base station for operation is to adjust the receiver lock band (switching range). The lock band is the range of frequencies that the receiver is calibrated to operate on.

Equipment

- Murata tuning tool
- CTU

To adjust the receiver lock band

1. Remove the reciter from the subrack. (For instructions, see the Installation and Operation Manual.)
2. Connect the Calibration Kit to the reciter (see [“Connecting to a Reciter Outside the Subrack”](#) on page 5).
3. Select the Frequency Setup tab, and double-click **Set Receiver VCO**. The Set Receiver VCO Wizard appears. The display varies, depending on the reciter band.
4. Enter the Center Frequency (which must be a multiple of 500 kHz) of the lock band that you want to use, and click **Next**.
5. Insert the Murata tuning tool into the correct receiver VCO tuning hole for the reciter type (see below) and then click **Next**.
6. Adjust the receiver VCO trimmer until the actual band matches the desired band. The bands turn green.
7. Click **Finish**. This stores the lock band in the reciter.

The icon  on the Frequency Setup tab indicates that this task is complete. Proceed to tune the front end.

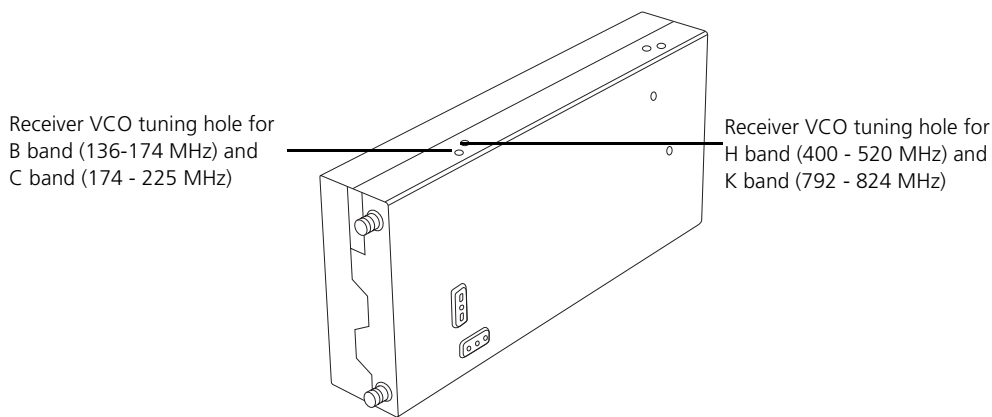

Tuning a UHF Receiver Front End

The second step in tuning the receiver frequency is to tune the receiver front end, by adjusting the helical filters. Tuning aims to maximise the receiver's sensitivity and to optimise its response across the lock band (switching range).

To help you do this, there is a graph of the RSSI readings in step two of the Tune Receiver Front End Wizard. A number of RSSI readings are measured across the switching range. These readings are then continually averaged to produce the graph.



Important: After tuning the receiver front end, you must re-calibrate the RSSI. This requires a signal generator. Otherwise the value reported by the Service Kit will be in error and RSSI gating levels will be incorrect.

You should aim to achieve a response that looks something like this:

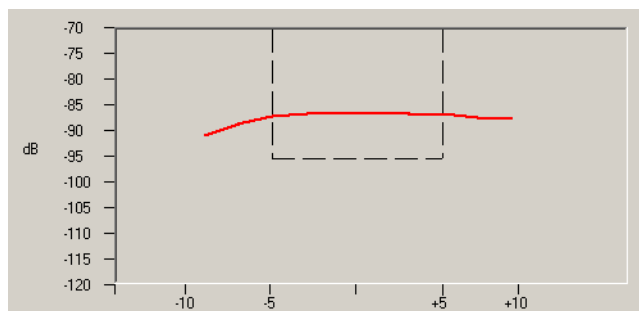

Equipment

- Johanson tuning tool
- CTU

Setup

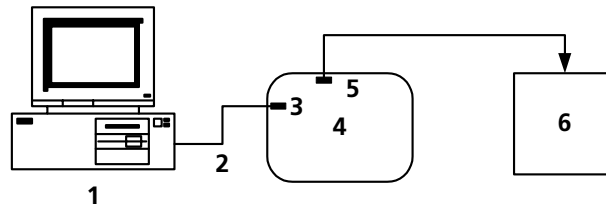

- 1 PC 2 RS-232 cable 3 Programming port
4 CTU 5 Noise source 6 Reciter

To tune the front end of a UHF (H-band or K-band) receiver, follow these steps.

1. Ensure you are already connected to the reciter (see [“Connecting to a Reciter Outside the Subrack”](#) on page 5).
2. Select the Frequency Setup tab, and double-click **Tune Receiver Front End**. The Tune Receiver Front End Wizard appears.



Note: If you haven't adjusted the receiver lock band in the current session, an alert appears, recommending that you run the Set Receiver VCO wizard first. If the lock band needs adjusting, click **Yes** and carry out that procedure first. If you are confident that the lock band is correct, click **No**.



3. Connect the CTU's noise source to the receiver input, turn the noise source on, and then click **Next**.
4. Click **Coarse (fast)** and use the tuning tool to roughly adjust the front-end helical filters on the receiver. As you do so, observe the graphical RSSI readings across the lock band. Adjust to maximize the response across the entire switching band.

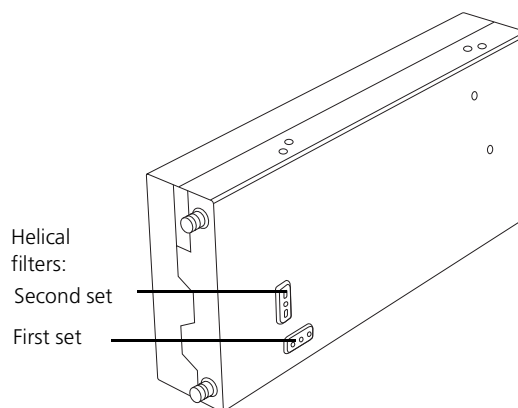

Note: As the response gets flatter, you may find it helpful to select a more sensitive scale, so that you can see the graphical reading in more detail.



Use the tuning tools as follows.

- a. Insert the Johanson tuning tool into the first hole of the first (horizontal) set. You can start with the hole on the left side and proceed along to the hole on the right, or vice versa. On K-band reciters, the third hole tends to tune with the slug well out of the filter body. Be careful not to unscrew the slug completely.
 - b. Tune each of the resonators in the first set once to give the best response.
 - c. Insert the Johanson tuning tool into the first hole of the second (vertical) set. You can start with the top hole and proceed down to the bottom hole, or vice versa. (For hardware version 4.00 or earlier H-band reciters, use the Murata tuning tool on this set instead, as instructed by the wizard.)
 - d. Tune each of the resonators in the second set once to give the best response.
 - e. Repeat this procedure as necessary to refine the response.
5. Once you have roughly tuned the front-end helical filters, click **Fine (slow)**. Repeat the above procedure to fine tune the front-end helical filters until the response is peaked in the middle of the lock band and not more than -1 dB at the ends of the band.
-  **Note:** When using the Fine (slow) setting, you may notice a slight delay as the reading from tuning the front-end helical filters takes approximately one second to appear on the graph.
6. Click **Finish**. An alert appears, asking that you calibrate the RSSI. The icon  on the Frequency Setup tab indicates that this task is complete.
 7. Re-calibrate the RSSI (see “[Calibrating the RSSI](#)” on page 19).

Tuning a VHF Receiver Front End

The second step in tuning a VHF reciter is to tune the receiver front end, by adjusting trimmer capacitors. Tuning aims to maximise the receiver’s sensitivity and to optimise its response across the lock band (switching range).

To help you do this, there is a graph of the RSSI readings in step two of the Tune Receiver Front End Wizard. A number of RSSI readings are measured across the switching range. These readings are then continually averaged to produce the graph.

After tuning the reciter front end, you must re-calibrate the RSSI. This requires a signal generator. Otherwise the value reported by the Service Kit will be in error and RSSI gating levels will be incorrect.

You should aim to achieve a response that looks something like this:

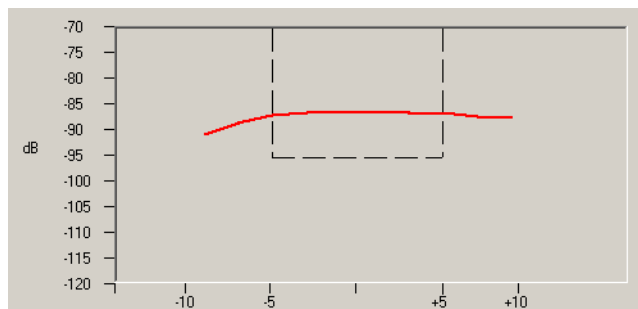

Equipment

- Tuning tool

■ CTU

Setup

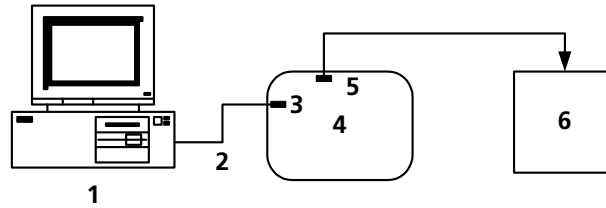

- 1 PC 2 RS-232 cable 3 Programming port
- 4 CTU 5 Noise source 6 Reciter

To tune a VHF (B-band or C-band) receiver front end, follow these steps.

1. Ensure you are already connected to the reciter (see [“Connecting to a Reciter Outside the Subrack”](#) on page 5).
2. Select the Frequency Setup tab, and double-click **Tune Receiver Front End**. The Tune Receiver Front End Wizard appears.



Note: If you haven't adjusted the receiver lock band in the current session, an alert appears, recommending that you run the Set Receiver VCO wizard first. If the lock band needs adjusting, click

Yes and carry out that procedure first. If you are confident that the lock band is correct, click **No**.

3. Connect the CTU's noise source to the receiver input, turn the noise source on, and then click **Next**.
4. Click **Coarse (fast)** and use the Murata tuning tool to roughly adjust the four front-end trimmers on the receiver. You can do this in any order. As you do so, observe the graphical RSSI readings across the lock band. Adjust to optimise the response across the entire switching band.



Note: As the response gets flatter, you may find it helpful to select a more sensitive scale, so that you can see the graphical reading in more detail.

5. Once you have roughly tuned the trimmers, click **Fine (slow)**. Repeat the above procedure until the response is flat in the middle of the lock band and not more than -1 dB at the ends of the band.



Note: When using the Fine (slow) setting, you may notice a slight delay as the reading from tuning the trimmers takes approximately one second to appear on the graph.

6. Click **Finish**. An alert appears, asking that you calibrate the RSSI. The icon  on the Frequency Setup tab indicates that this task is complete.
7. Re-calibrate the RSSI (see [“Calibrating the RSSI”](#) on page 19).

Trimmer holes for receiver front-end tuning (B band 136 - 174 MHz and C band 174 - 225 MHz)

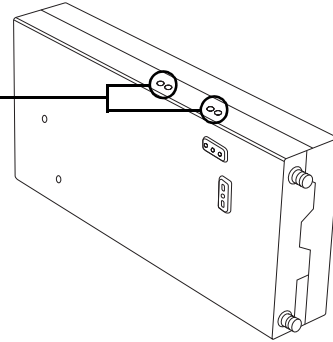

Adjusting the Exciter Lock Band

If you are preparing the base station for operation, adjusting the exciter lock band is the third step in tuning the reciter. Alternatively, this procedure can be performed independently of the other two calibration wizards on the Frequency Setup tab. Adjusting the exciter lock band defines the range of frequencies that the base station is able to transmit on.



Note: When performing this procedure, you don't need to terminate the exciter output port. An internal output pad means that there is a good impedance match at this interface.

Equipment

- Tuning tool
- CTU

To calibrate the exciter lock band

1. Ensure you are already connected to the reciter (see [“Connecting to a Reciter Outside the Subrack”](#) on page 5).
2. Select the Frequency Setup tab, and double-click **Set Exciter VCO**. The Set Exciter VCO Wizard appears.
3. Enter the center frequency (which must be a multiple of 500 kHz) of the lock band that you want to use, and click **Next**.
4. Insert the Murata tuning tool into the correct exciter VCO tuning hole (see below) and adjust the trimmer until the actual band matches the desired band. The bands turn green. Click **Finish**.

Once you have finished adjusting the exciter lock band, the icon  on the Frequency Setup tab indicates that this task is complete.

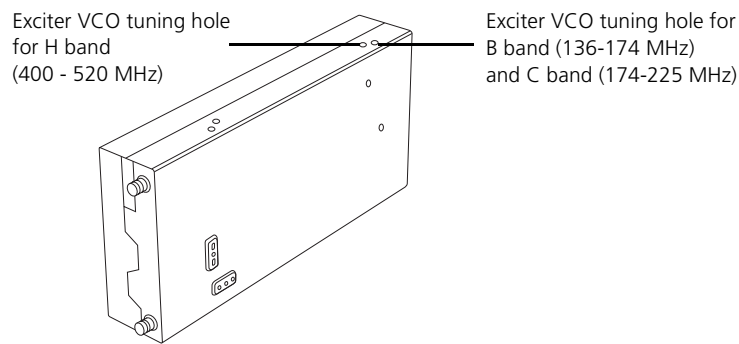

Selecting the Exciter Sub-band

The lock band of K-band and L-band exciters does not normally need adjusting. Instead you select a sub-band that the reciter will operate on. These exciters have two VCOs and the one you select determines the sub-band.

Equipment

- Murata tuning tool
- CTU

To select the exciter sub-band

1. Ensure you are already connected to the reciter (see [“Connecting to a Reciter Outside the Subrack”](#) on page 5).
2. Select the Frequency Setup tab, and double-click **Set/Select Exciter VCO**. The Set/Select Exciter VCO Wizard appears.
3. Select one of the two available lock bands and then click **Next**. This specifies the lock band that the exciter operates in.
4. If the reciter RF board has been repaired, you need to adjust the lock band. Insert the Murata tuning tool into the correct exciter VCO tuning hole (see below) and adjust the trimmer until the actual band matches the desired band. The bands turn green.
5. Click **Finish**.

Once you have finished, the icon  on the Frequency Setup tab indicates that this task is complete.

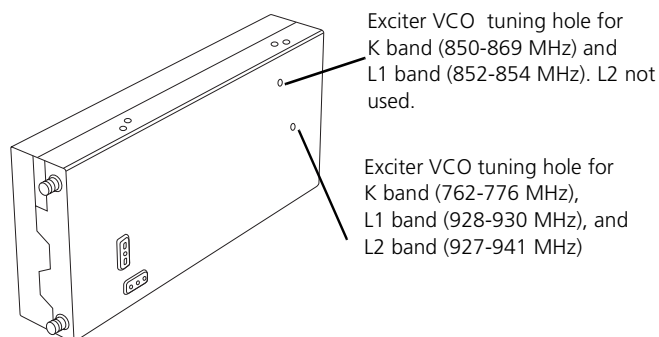

Calibrating the Reciter

The reciter is fully calibrated in the factory, but if the reciter is serviced you may need to perform the following procedures:

- [Calibrating the Exciter](#)
- [Calibrating the RSSI](#)
- [Audio Calibration](#)

To compensate for frequency drift, you may need to perform the following:

- [Carrier Frequency Offset Adjustment \(Older Reciters\)](#) or
- [Carrier Frequency Offset Adjustment \(Newer Reciters\)](#)

All these procedures can be done independently of each other, although it is recommended that you tune the receiver *before* you calibrate the RSSI.



Important: It is recommended that only accredited service centers and Tait engineers perform these procedures.

Calibrating the Exciter

You will need to calibrate the exciter if you have made component-level repairs to it. There are three procedures that must all be completed in order:

1. [Auto-tune the FCL](#)
2. [Calibrate the FCL](#)
3. [Calibrate the VCO](#)

Automatically Tune the Frequency Control Loop (FCL)

Tuning the FCL calibrates the voltage levels used in the detectors for the FCL.

To automatically tune the FCL

1. [Connect the Calibration Kit PC to the reciter](#) and start the Calibration Kit.
2. Select the Reciter Calibration tab, and double-click **FCL Auto Tuning**. The FCL Auto Tuning Wizard appears.
3. Click **Calibrate** to automatically tune the FCL.

The icon  on the Reciter Calibration tab indicates that this task is complete. You will now need to [calibrate the FCL](#).

Calibrating the FCL

This is step two of calibrating the exciter. Once you have auto-tuned the FCL, you should calibrate it.

Equipment

- Tuning tool
- CTU
- Modulation meter
- RF attenuator (only required if you are using a PA)

Setup

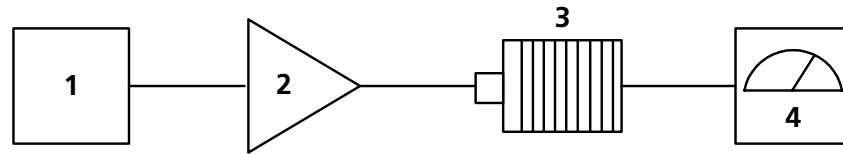

- | | |
|-----------------|---|
| 1 Reciter | 3 RF attenuator (only required if using a PA) |
| 2 PA (optional) | 4 Modulation meter |

To calibrate the FCL

1. Ensure that the Calibration Kit PC is [connected to the reciter](#).
2. Select the Reciter Calibration tab, and double-click **FCL Calibration**. The FCL Calibration Wizard appears.
3. Attach an appropriate Load and Modulation meter to the PA or exciter output, set the meter to measure the RMS deviation, and then click **Next**. (If you are using a PA, it will now transmit.)
4. Insert the Murata tuning tool into the correct exciter VCO tuning hole (see below) and adjust the trimmer until the actual band matches the desired band. The bands turn green. Click **Next**.
5. Use the slider to adjust the deviation at 1 kHz until it is 2107 Hz RMS (3 kHz peak).
6. Select the 30 Hz Modulation Test and adjust the deviation at 30 Hz until it is 2107 Hz RMS (3 kHz peak).
7. Repeat steps 5 and 6 until the deviation is 2107 Hz RMS at both 1 kHz and 30 Hz.
8. Click **Finish**. (If you are using a PA, it will now stop transmitting.)

When you have finished calibrating the FCL, the icon  on the Reciter Calibration tab indicates that this task is complete.

You will now need to [calibrate the VCO](#).

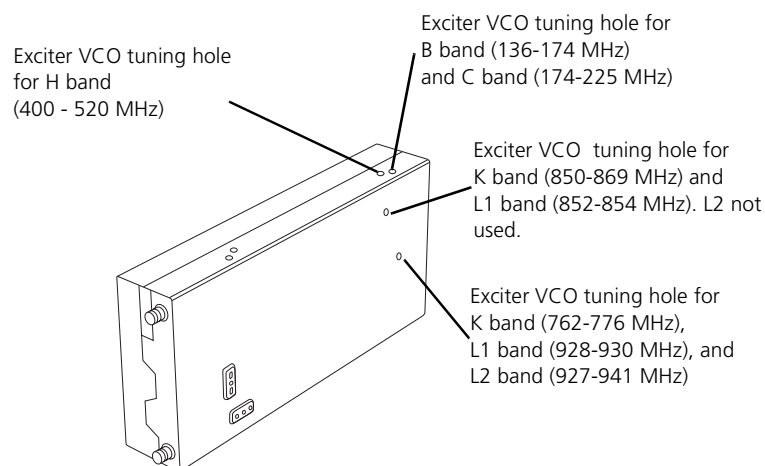

Calibrating the VCO

This is step three of calibrating the exciter.

Once you have tuned and calibrated the FCL, you calibrate the VCO at frequencies across the whole lock band. This involves selecting a sub-band, adjusting the lock band trimmer, and then moving on-screen sliders to adjust the deviation to 3 kHz for each of a set of frequencies.

Equipment

- Tuning tool
- CTU
- Modulation meter
- RF attenuator (only required if you are using a PA)

Setup

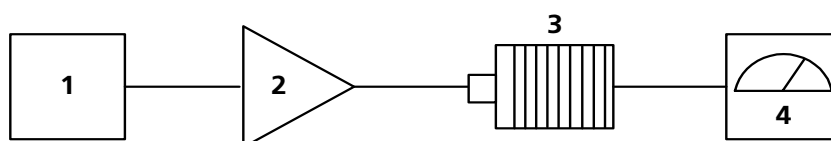

- | | |
|-----------------|---|
| 1 Reciter | 3 RF attenuator (only required if using a PA) |
| 2 PA (optional) | 4 Modulation meter |

To calibrate the VCO

1. Ensure that the Calibration Kit PC is [connected to the reciter](#).
2. Select the Reciter Calibration tab, and double-click **VCO Calibration**. The VCO Calibration Wizard appears.
3. Attach an appropriate Load and Modulation meter to the PA or exciter output, set the meter to measure the peak deviation, and then click **Next**. (If you are using a PA, it will now transmit.)
4. Adjust the exciter lock band trimmer until the actual band matches the desired band. The bands turn green.
5. Click **Next**. Step 3 of the wizard appears.
6. Calibrate each of the frequencies shown. Follow these steps.
 - a. Click the option button alongside a frequency.
 - b. Using the Fine and Coarse arrows, adjust the slider until the deviation shown on the modulation meter is 3000 Hz (peak).
 - c. Repeat steps a) and b) until all frequencies for the band are calibrated. This enables the **Next Band** button.
7. Click **Next Band** and repeat steps 4) through 6). Repeat until all frequencies in all bands have been calibrated.
8. If you are connected to a K-band or L1-band reciter, click **Next**. Select which of the two available bands the reciter will operate on.
9. Click **Finish**. (If you are using a PA, it will now stop transmitting.)

When you have finished calibrating the VCO, the icon  on the Reciter Calibration tab indicates that this task is complete.

You should now [adjust the exciter lock band](#) because it was re-tuned several times during this procedure. This means that the exciter is no longer on the required frequency.

Calibrating the RSSI

Calibrating the RSSI (received signal strength indicator) ensures that the reciter's internal RSSI values accurately reflect the actual received signal strength. Changing the receiver's lock band can alter the calibration accuracy by about 1 dB.



Note: Ensure that the receiver's lock band has already been adjusted to the required setting before carrying out this procedure. (See [“Adjusting the Receiver Lock Band”](#) on page 9.)

Equipment

- RF signal source

Setup

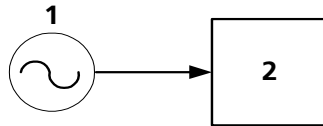

- 1 RF signal source
- 2 Reciter

To calibrate the RSSI

1. Ensure that the Calibration Kit PC is [connected to the reciter](#).
2. Select the Reciter Calibration tab, and double-click **RSSI Calibration**. An alert appears, recommending that you tune the receiver. If the receiver needs tuning, click **Yes** and carry out that procedure before continuing. If you are confident that the receiver is correctly tuned, click **No**. The RSSI Calibration Wizard appears.
3. Apply a signal (modulated at 1 kHz tone, 3kHz deviation peak) at the base station's center frequency. Use the CTU to confirm that the tone is being output on the line, and then click **Next**.
4. Set the RF input signal to a level of -80 dBm, and then click **Next**.
5. Vary the RF level, and check that the value shown in the RSSI Gain Setting box corresponds with the value shown on your test instrument. This is to make sure the RSSI is correctly calibrated. Click **Finish**.

When you have finished calibrating the RSSI, the icon  on the Reciter Calibration tab indicates that this task is complete.

Audio Calibration

You should calibrate the audio outputs/inputs if the system interface has been replaced or changed at all.



Note: The balanced and unbalanced lines can be calibrated independently of each other.

Calibrating the Balanced Lines

Calibrating the balanced lines adjusts their gain, so that when you set line levels using the TB8100 Service Kit software, the actual line level correctly reflects the Service Kit settings. (Refer to the *TB8100 Service Kit User's Manual* for further information.)

Equipment

- CTU
- AC millivoltmeter



Important: If the reciter you are calibrating has either the product code TBA4xxx-0A0x or TBA5xxx-0A0x, its balanced line output is not transformer isolated. Ensure that the line meter you are using has a differential input otherwise the balanced line output will not be calibrated properly.

Setup for Balanced Line Out

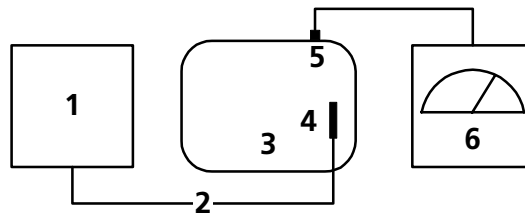

- | | | | | | |
|---|--------------|---|-----------------------|---|-------------------|
| 1 | Reciter | 3 | CTU | 5 | Line output |
| 2 | 25-way cable | 4 | System interface port | 6 | AC millivoltmeter |

Setup for Balanced Line In

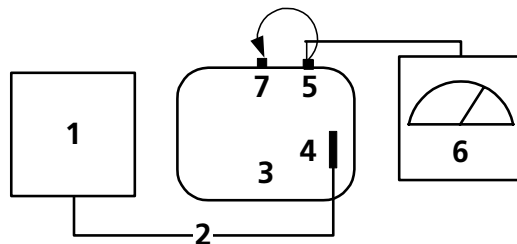

- | | | | | | |
|---|--------------|---|-----------------------|---|-------------------|
| 1 | Reciter | 3 | CTU | 5 | Line output |
| 2 | 25-way cable | 4 | System interface port | 6 | AC millivoltmeter |
| 7 | Line input | | | | |

To calibrate the balanced input and output lines

1. Ensure that the Calibration Kit PC is [connected to the reciter](#).
2. Select the Reciter Calibration tab, and double-click **Balanced Line Calibration**. The Balanced Line Calibration Wizard appears.
3. Attach an AC millivoltmeter and terminate the balanced output in 600 ohms (*either* using the load on the CTU *or* looping the balanced output to the balanced input), and then click **Next**.
4. Adjust the slider in the dialog box until the audio level on the millivoltmeter reads 1 VPP (0.354 VRMS).



Note: Click **Coarse** to roughly adjust the audio level, and once you get within range, click **Fine** for more precise control over the settings. To move up or down 10 mVPP, click either side of the slider bar.

5. Click **Next**. The balanced output is now calibrated.
6. Note the level of the AC millivoltmeter, and then turn off the 600 ohm load.
7. Connect the balanced output to the balanced input. Verify that the millivoltmeter reading is substantially unchanged. (This confirms that the input provides a 600 ohm impedance.)
8. Click **Finish**. The balanced input is now calibrated.

When you have finished calibrating the balanced lines, the icon  on the Reciter Calibration tab indicates that this task is complete.

Calibrating the Unbalanced Lines

Calibrating the unbalanced lines adjusts their gain, so that when you set line levels using the TB8100 Service Kit software, the actual line level correctly reflects the Service Kit settings. (Refer to the *TB8100 Service Kit User's Manual* for further information.)

Equipment

- CTU
- AC millivoltmeter

Setup for Unbalanced Line Out

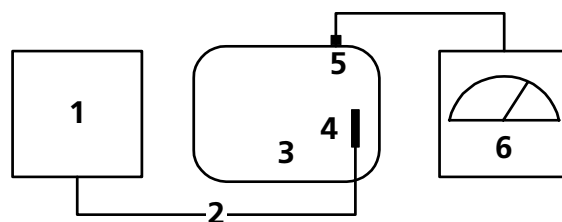

- | | | | | | |
|---|--------------|---|-----------------------|---|------------------------|
| 1 | Reciter | 3 | CTU | 5 | Unbalanced line output |
| 2 | 25-way cable | 4 | System interface port | 6 | AC millivoltmeter |

Setup for Unbalanced Line In

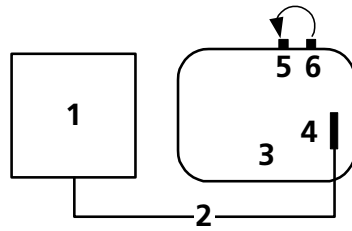

- | | | | | | |
|---|--------------|---|-----------------------|---|------------------------|
| 1 | Reciter | 3 | CTU | 5 | Unbalanced line input |
| 2 | 25-way cable | 4 | System interface port | 6 | Unbalanced line output |

To calibrate the unbalanced input and output lines

1. Ensure that the Calibration Kit PC is [connected to the reciter](#).
2. Select the Reciter Calibration tab, and double-click **Unbalanced Line Calibration**. The Unbalanced Line Calibration Wizard appears.
3. Attach an AC millivoltmeter to the unbalanced line output, and then click **Next**.
4. Adjust the slider in the dialog box until the audio level on the millivoltmeter reads 1 VPP (0.354 VRMS) to calibrate the unbalanced line output, and then click **Next**.



Note: Click **Coarse** to roughly adjust the audio level, and once you get within range, click **Fine** for more precise control over the settings. To move up or down 10 mVPP, click either side of the slider bar.

The unbalanced line output is now calibrated.

5. Connect the unbalanced output to the unbalanced input, and then click **Finish**.

The unbalanced line input is now calibrated.

When you have finished calibrating the unbalanced lines, the icon  on the Reciter Calibration tab indicates that this task is complete.

Carrier Frequency Offset Adjustment (Older Reciters)

The carrier frequency is derived from a reference frequency generated by the reciter's TCXO (temperature compensated crystal oscillator). The reference frequency can drift over time, causing an offset to the carrier frequency. When you connect to a reciter with hardware version 00.02 or earlier, the Calibration Kit provides the following procedure that enables you to adjust the carrier frequency and remove the offset.

Reciters are delivered from the factory with a 0 offset. Carry out the following procedure if you suspect that the base station is transmitting off-frequency. (Off-frequency is defined as being outside the range of -1 to +1 ppm.) It is a good idea to calibrate the TCXO every few years. Exactly how often you do this will depend on the harshness of the conditions in which the base station is operating.

Ideally, you should calibrate the TCXO at a room temperature of 25 +/- 5 degrees Celsius. Complete the calibration as quickly as possible since extended transmission times increase temperature, which makes the calibration less accurate.



Important: Do not carry out this procedure on reciters that are intended for use in a quasi-synchronous system.

Equipment

- Frequency counter
- RF attenuator (only required if you are using a PA)



Important: The accuracy of the calibrated TCXO frequency is only as good as the accuracy of the frequency counter.

Setup

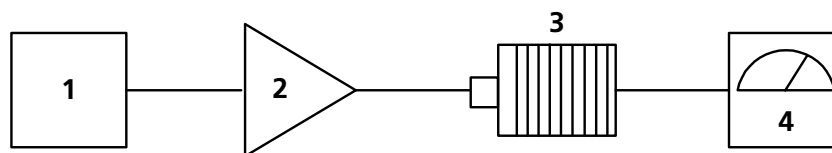

- | | |
|-----------------|--------------------------------|
| 1 Reciter | 3 RF Attenuator pad (optional) |
| 2 PA (optional) | 4 Frequency counter |

To adjust the carrier frequency

1. Ensure that the Calibration Kit PC is connected to the reciter (see [“Connecting to a Reciter via the Control Panel”](#) on page 7).
2. Select the Reciter Calibration tab, and double-click **Carrier Freq Offset Adjustment**. The Carrier Freq Offset Adjustment Wizard appears.
3. Attach an appropriate load and frequency counter (or a test set) to the exciter or PA output, and then click **Next**. (This instructs the setup to transmit.)
4. Using the slider, adjust the TCXO pot until the actual frequency is exactly the same as the selected frequency value. Click **Coarse** to roughly (and quickly) adjust the output frequency, and then click **Fine** to fine-tune it. When you have finished, click **Finish**. (The setup now stops transmitting.)

When you have finished, the icon  on the Reciter Calibration tab indicates that this task is complete.

Carrier Frequency Offset Adjustment (Newer Reciters)

The TCXO (temperature compensated crystal oscillator) provides a reference frequency from which all other RF frequencies are derived. Reciters with hardware version 00.03 and above have a voltage-controlled TCXO, with a pot for adjusting the reference frequency to remove any carrier frequency offset. The Carrier Freq Offset Adjustment wizard provides assistance with this procedure.

Tait recommends that the reciter TCXO is recalibrated after 3 months service and that annual checks are made thereafter in order to compensate for frequency drift. Recalibration ensures that the SDB (signal displacement bandwidth) is within 250 Hz.

The TCXO has a frequency stability of 0.5 ppm (parts per million) corresponding to 250 Hz at a carrier frequency of 500 MHz. Tait recommends that the TCXO is calibrated to within 0.1 ppm.

Equipment

- Torx 10 screwdriver (to remove the reciter cover)
- Tuning tool
- Frequency counter
- RF attenuator (only required if you are using a PA)



Important: The accuracy of the calibrated TCXO frequency is only as good as the accuracy of the frequency counter.

Setup

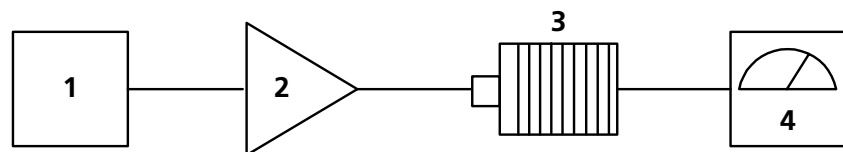

- | | |
|-----------------|--------------------------------|
| 1 Reciter | 3 RF Attenuator pad (optional) |
| 2 PA (optional) | 4 Frequency counter |

You need direct access to the TCXO circuitry on the reciter RF board. This involves removing the reciter RF cover.



Important: The reciter contains devices that are susceptible to damage from static charges. You must handle these devices according to the recommended ESD precautions.

To adjust the carrier frequency

1. Remove the reciter from the subrack.
2. Remove the M3 Torx screws securing the reciter RF cover to the heatsink and to the front and rear panels. (The RF side of the reciter can be identified by the two BNC connectors on that side of the reciter's rear.) Lift off the RF cover.
3. Connect the Calibration Kit to the reciter (see [“Connecting to a Reciter Outside the Subrack”](#) on page 5).
4. Select the Reciter Calibration tab, and double-click **Carrier Freq Offset Adjustment**. The Carrier Freq Offset Adjustment wizard appears.

5. Attach an appropriate load and frequency counter (or a test set) to the exciter or PA output, and then click **Next**.

The exciter now begins transmitting on the center frequency of its lock band. The Wizard displays a message similar to the following:

“Adjust RV1400 to set frequency within 0.1 ppm or 48Hz of 485 MHz”

6. Use the tuning tool to adjust the TCXO tuning control (RV1400) so that the reciter is transmitting exactly on frequency.

The following shows where the tuning control is located on B-band, C-band, and H-band reciters:

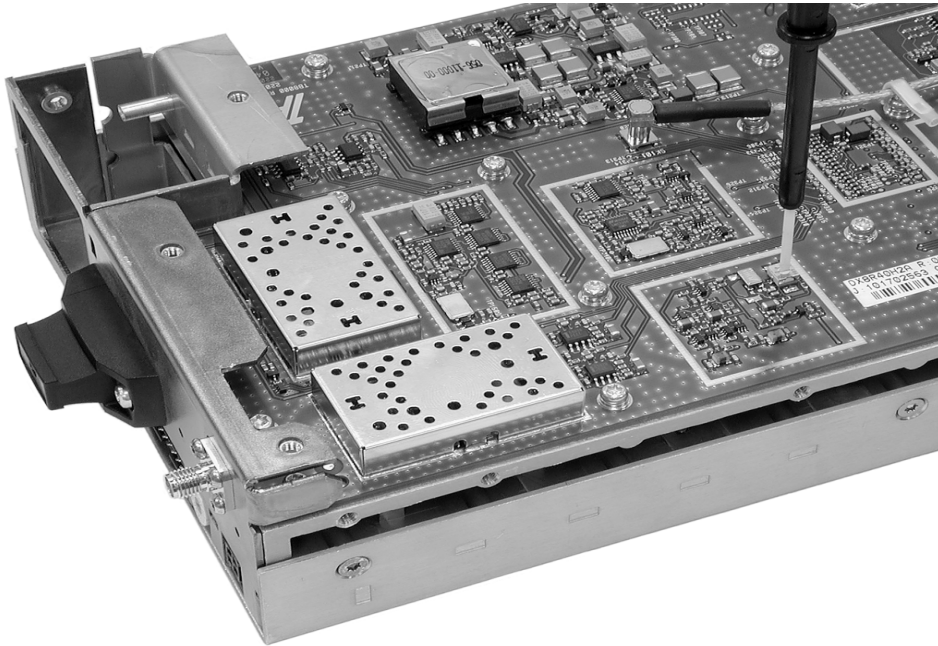

The following shows where the tuning control is located on K-band and-L band reciters:

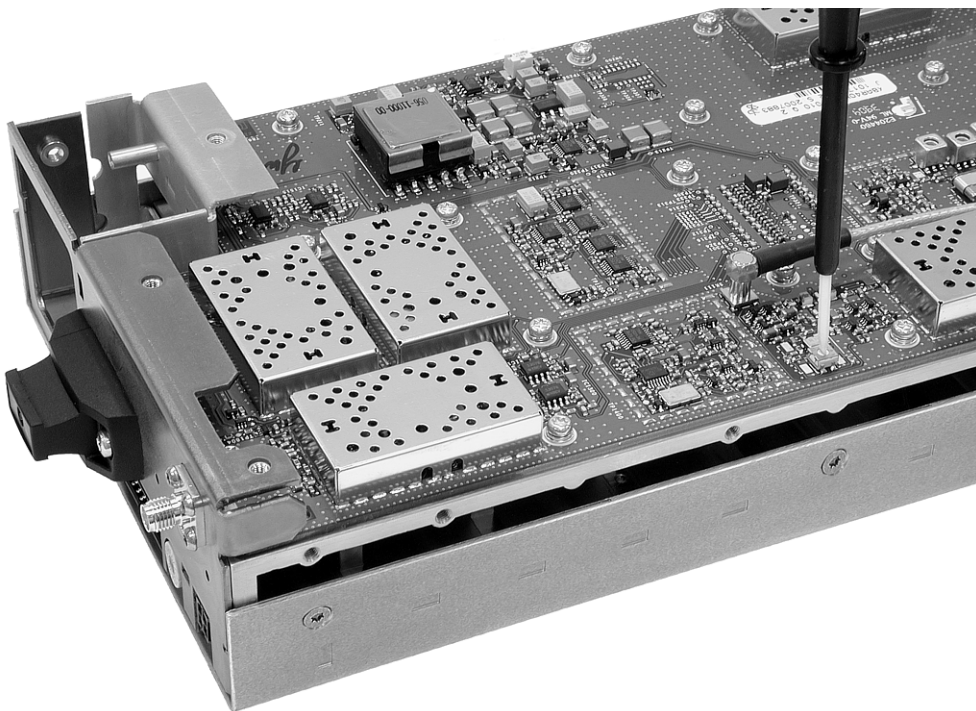

7. Click **Finish**. Transmission ceases and the icon  on the Reciter Calibration tab indicates that this task is complete.
8. Replace the reciter RF cover, as follows.
 - a. Slide the cover into place over the front and rear panels. Make sure the holes in the cover line up with the threaded holes in the heatsink and front and rear panels.
 - b. Press the cover firmly into place and screw in the M3 Torx screws, first on the flat face, then on the edge face.



Important: Excessively tightening the screws can damage the thread of the aluminium heatsink. Tait recommends that you use a T10 torque driver set to 0.5 Newton meters (4.5 foot pounds).

Calibrating the Power Amplifier

The PA is fully calibrated in the factory, but if the PA is serviced you may need to perform the following procedures:

- [Calibrating the PA Bias](#)
- [Calibrating the Forward and Reverse Detector Bias Voltages](#)
- [Calibrating the PA Power](#)

Perform the procedures in the above order.



Important: It is recommended that only accredited service centers and Tait engineers perform these procedures.

Calibrating the PA Bias

The driver and final transistors of the power amplifier must be biased at a constant current. Since the characteristics of individual transistors vary slightly, the bias current is calibrated for each device.

If either the driver or final transistor, or the PCB modules themselves, are replaced during servicing, you should perform this procedure to calibrate the bias current for the new device.

The bias current required for each amplifier stage is stored within the PA. During the calibration process, the microprocessor adjusts the gate bias voltage to obtain the required bias current for each stage.

The stage bias calibration sets up the amplifier's DC operating conditions. These DC conditions will be upset if there is RF present during calibration. It is important to disconnect the RF cable from the PA input to avoid this.

The other conditions which must be met to ensure a successful calibration are as follows:

- No other Calibration Wizards are running
- The supply voltage is within the range 27-29V
- The temperature of each stage is within the range 5-50°C

To calibrate the PA stage bias current

1. Ensure that the Calibration Kit PC is [connected to the base station](#).
2. Select the PA Calibration tab, and double-click **Calibrate PA Bias**.
3. Ensure that the exciter RF is isolated from the PA by disconnecting the SMA connector on the PA front panel.
4. Click **Calibrate** to calibrate the PA bias.

When you have finished calibrating the power amplifier bias, the icon  on the PA Calibration tab indicates that this task is complete.

Calibrating the Forward and Reverse Detector Bias Voltages

The RF detectors, used for measuring the forward and reverse power, operate with a small bias current. The resulting bias voltage from each detector (with no RF present) is read and stored inside the PA. These voltages are used when calculating the Antenna VSWR (Voltage Standing Wave Ratio).

You should calibrate the forward and reverse detector bias voltages:

- If the Low Pass Filter (LPF)/directional coupler PCB module is replaced
- After servicing of any components in the detector circuitry (such as the detector diodes) on the LPF/ directional coupler PCB

To calibrate the forward and reverse detector bias voltages

1. Ensure that the Calibration Kit PC is [connected to the base station](#).
2. Select the PA Calibration tab, and double-click **Calibrate Fwd/Rev Detector Bias Voltages**.
3. Ensure that the PA is not transmitting and that there is no RF source present at the PA RF input or output by disconnecting the input SMA connector on the PA front panel and the 'N' type output connector from the rear of the PA. Click **Calibrate**.

When you have finished, the icon  on the PA Calibration tab indicates that this task is complete.

Calibrating the PA Power

The power amplifier (PA) receives the RF signal from the reciter and amplifies it to the required level, in watts, as requested by the reciter. The desired output power is determined by the reference voltage for the power control loop.

The PA power control loop is calibrated at a single frequency, generally in the center of the operating band.

You perform the calibration procedure to define – for each power level – the reference DAC (Digital-to-Analogue Converter) value and forward detector voltage.

You should only need to re-calibrate the PA power if:

- The Low Pass Filter (LPF)/directional coupler PCB module is replaced
- Any repairs are carried out on the forward and reverse detector circuitry on the Low Pass Filter/directional coupler PCB module
- You require a more accurate power calibration on a specific frequency

Equipment

- *Either* an inline power meter and 50 ohm load with a high power rating, *or*
- A terminating power meter and appropriate 50 ohm attenuator with a high power rating

Setup for Inline Power Meter

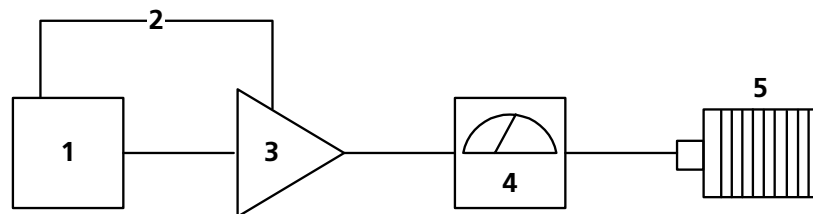

- | | | |
|----------------|------------------|--------|
| 1 Reciter | 3 PA | 5 Load |
| 2 16-way cable | 4 RF Power Meter | |



Note: Cables and connectors can easily cause a power loss of several watts if either too long or poorly terminated. Always use the shortest possible leads (or connectors instead of leads) between the PA and power meter set-up.

To calibrate the PA transmit power

1. Ensure that the Calibration Kit PC is [connected to the base station](#).
2. Select the PA Calibration tab, and select **Calibrate PA Power**.
3. Ensure that the power meter and a 50 ohm load (VSWR < 1.2:1) with a high power rating are connected to the power amplifier RF output, and then click **Next**.
4. Check that the PA RF input is connected to the reciter RF output, and that the PA and the reciter are connected by a control bus, and then click **Next**.
5. For each power level shown, use the slider to adjust the DAC setting to get the required power output, and then click **Next Power** to move to the next line.



Note: Click **Coarse** to roughly adjust the DAC setting, and once you get within range, click **Fine** for more precise control over the settings. To move up or down one DAC value, click either side of the slider bar.



Note: You must perform the calibration in sequence from the lowest to the highest step. The DAC setting must be greater than the previous one otherwise the value will not be stored in the PA, and you cannot move to the next line.

6. When you have completed adjusting the DAC settings, click **Finish**.

When you have finished, the icon  on the PA Calibration tab indicates that this task is complete.

Troubleshooting Tips

DAC Settings

When you adjust the DAC settings, the values for the DAC Setting, Coupler Fwd Voltage, and Control Voltage should always increase as the power level increases. If these values do not increase, there is either a fault with the PA or the previous step was not calibrated correctly. If you make a mistake in the calibration table, you must start again from step 1.

Control Voltage

The Control Voltage is shown in the table to indicate the operation point within the power control loop. The range of the control voltage is from 0 V to 7.5 V. If the control voltage reaches its limit before achieving maximum power in the table, this indicates either a faulty gain stage in the PA or low RF input power to the PA.

VSWR

The VSWR (Voltage Standing Wave Ratio) is monitored at the RF output of the PA during calibration. The software will not allow calibration into a load VSWR > 1.3:1. If a calibration step cannot be stored, check that the load VSWR is <1.3:1. It is recommended that the load should have an input VSWR <1.2:1.

Calibrating the Power Management Unit

There is only one calibration procedure for the PMU: calibrating its output voltage.

Calibrating the PMU Output Voltage

Calibrating the PMU output voltage adjusts the voltage to be 28.00 V. This procedure is only carried out when a replacement control card or microprocessor is fitted to the PMU. Normally, the output voltage will be accurate without calibration.



Note: Re-calibrating the PMU output voltage may result in it failing to meet the published specification of +/- 0.5% accuracy. This is because control cards are calibrated in the factory under half-load, giving a voltage that is closer to 28.00 V under varying loads.

To calibrate the output voltage

1. Connect the Calibration Kit to the base station (see [“Connecting to a Reciter via the Control Panel”](#) on page 7).
2. Select the **PMU Calibration** tab.
3. Double-click **Output Voltage Calibration**. The Calibrate Output Voltage wizard appears.
4. Connect a digital multimeter to the PMU output and read the output voltage.
5. Enter the voltage into the **PMU Voltage** box and click **Calibrate**.
6. When the wizard indicates that the calibration completed successfully, click **Finish**.

Tait General Software Licence Agreement

This legal document is an Agreement between you (the "Licensee") and Tait Electronics Limited ("Tait"). By using any of the Software or Firmware items prior-installed in the related Tait product, included on CD or downloaded from the Tait website, (hereinafter referred to as "the Software or Firmware") you agree to be bound by the terms of this Agreement. If you do not agree to the terms of this Agreement, do not install and use any of the Software or Firmware. If you install and use any of the Software or Firmware that will be deemed to be acceptance of the terms of this licence agreement.

The terms of this Agreement shall apply subject only to any express written terms of agreement to the contrary between Tait and the Licensee.

Licence

TAIT GRANTS TO YOU AS LICENSEE THE NON-EXCLUSIVE RIGHT TO USE THE SOFTWARE OR FIRMWARE ON A SINGLE MACHINE PROVIDED YOU MAY ONLY:

1. COPY THE SOFTWARE OR FIRMWARE INTO ANY MACHINE READABLE OR PRINTED FORM FOR BACKUP PURPOSES IN SUPPORT OF YOUR USE OF THE PROGRAM ON THE SINGLE MACHINE (CERTAIN PROGRAMS, HOWEVER, MAY INCLUDE MECHANISMS TO LIMIT OR INHIBIT COPYING, THEY ARE MARKED "COPY PROTECTED"), PROVIDED THE COPYRIGHT NOTICE MUST BE REPRODUCED AND INCLUDED ON ANY SUCH COPY OF THE SOFTWARE OR FIRMWARE;
AND / OR

2. MERGE IT INTO ANOTHER PROGRAM FOR YOUR USE ON THE SINGLE MACHINE (ANY PORTION OF ANY SOFTWARE OR FIRMWARE MERGED INTO ANOTHER PROGRAM WILL CONTINUE TO BE SUBJECT TO THE TERMS AND CONDITIONS OF THIS AGREEMENT).

THE LICENSEE MAY NOT DUPLICATE, MODIFY, REVERSE COMPILATE OR REVERSE ASSEMBLE ANY SOFTWARE OR FIRMWARE IN WHOLE OR PART.

Important Notice

THE SOFTWARE OR FIRMWARE MAY CONTAIN OPEN SOURCE SOFTWARE COMPONENTS ("OPEN SOURCE COMPONENTS"). OPEN SOURCE COMPONENTS ARE EXCLUDED FROM THE TERMS OF THIS AGREEMENT EXCEPT AS EXPRESSLY STATED IN THIS AGREEMENT AND ARE COVERED BY THE TERMS OF THEIR RESPECTIVE LICENCES WHICH MAY EXCLUDE OR LIMIT ANY WARRANTY FROM OR LIABILITY OF THE DEVELOPERS AND/OR COPYRIGHT HOLDERS OF THE OPEN SOURCE COMPONENT FOR THE PERFORMANCE OF THOSE OPEN SOURCE COMPONENTS. YOU AGREE TO BE BOUND BY THE TERMS AND CONDITIONS OF EACH SUCH LICENCE. FOR MORE INFORMATION SEE:

<http://support.taitworld.com/go/opensource>

Title to Software

THIS AGREEMENT DOES NOT CONSTITUTE A CONTRACT OF SALE IN RELATION TO THE SOFTWARE OR FIRMWARE SUPPLIED TO THE LICENSEE. NOTWITHSTANDING THE LICENSEE MAY OWN THE MAGNETIC OR OTHER PHYSICAL MEDIA ON WHICH THE SOFTWARE OR FIRMWARE WAS ORIGINALLY SUPPLIED, OR HAS SUBSEQUENTLY BEEN RECORDED OR FIXED, IT IS A FUNDAMENTAL TERM OF THIS AGREEMENT THAT AT ALL TIMES TITLE AND OWNERSHIP OF THE SOFTWARE OR FIRMWARE, WHETHER ON THE ORIGINAL MEDIA OR OTHERWISE, SHALL REMAIN VESTED IN TAIT OR THIRD PARTIES WHO HAVE GRANTED LICENCES TO TAIT.

Term and Termination

THIS LICENCE SHALL BE EFFECTIVE UNTIL TERMINATED IN ACCORDANCE WITH THE PROVISIONS OF THIS AGREEMENT. THE LICENSEE MAY TERMINATE THIS LICENCE AT ANY TIME BY DESTROYING ALL COPIES OF THE SOFTWARE OR FIRMWARE AND ASSOCIATED WRITTEN MATERIALS. THIS LICENCE WILL BE TERMINATED AUTOMATICALLY AND WITHOUT NOTICE FROM TAIT IN THE EVENT THAT THE LICENSEE FAILS TO COMPLY WITH ANY TERM OR CONDITION OF THIS AGREEMENT. THE LICENSEE AGREES TO DESTROY ALL COPIES OF THE SOFTWARE OR FIRMWARE AND ASSOCIATED WRITTEN MATERIALS IN THE EVENT OF SUCH TERMINATION.

Limited Warranty

THE SOFTWARE OR FIRMWARE (INCLUDING OPEN SOURCE COMPONENTS) IS SUPPLIED BY TAIT AND ACCEPTED BY THE LICENSEE "AS IS" WITHOUT WARRANTY OF ANY KIND EITHER EXPRESSED OR IMPLIED, INCLUDING BUT NOT BEING LIMITED TO ANY IMPLIED WARRANTIES AS TO MERCHANTABILITY OR FITNESS FOR ANY PARTICULAR PURPOSE. THE LICENSEE ACKNOWLEDGES THAT THE SOFTWARE OR FIRMWARE (INCLUDING OPEN SOURCE COMPONENTS) IS USED BY IT IN BUSINESS AND ACCORDINGLY TO THE MAXIMUM EXTENT PERMITTED BY LAW NO TERMS OR WARRANTIES WHICH ARE IMPLIED BY LEGISLATION SHALL APPLY TO THIS AGREEMENT. TAIT DOES NOT WARRANT THAT THE FUNCTIONS CONTAINED IN THE SOFTWARE OR FIRMWARE (INCLUDING OPEN SOURCE COMPONENTS) WILL MEET THE LICENSEE'S REQUIREMENTS OR THAT THE OPERATION OF THE SOFTWARE OR FIRMWARE (INCLUDING OPEN SOURCE COMPONENTS) WILL BE UNINTERRUPTED OR ERROR FREE.

Exclusion of Liability

IN NO CIRCUMSTANCES SHALL TAIT BE UNDER ANY LIABILITY TO THE LICENSEE, OR ANY OTHER PERSON WHATSOEVER, WHETHER IN TORT (INCLUDING NEGLIGENCE), CONTRACT (EXCEPT AS EXPRESSLY PROVIDED IN THIS AGREEMENT), EQUITY, UNDER ANY STATUTE, OR OTHERWISE AT LAW FOR ANY LOSSES OR DAMAGES WHETHER GENERAL, SPECIAL, EXEMPLARY, PUNITIVE, DIRECT, INDIRECT OR CONSEQUENTIAL ARISING OUT OF OR IN CONNECTION WITH ANY USE OR INABILITY OF USING THE SOFTWARE OR FIRMWARE (INCLUDING OPEN SOURCE COMPONENTS).

THE LICENSEE'S SOLE REMEDY AGAINST TAIT WILL BE LIMITED TO BREACH OF CONTRACT AND TAIT'S SOLE AND TOTAL LIABILITY FOR ANY SUCH CLAIM SHALL BE LIMITED AT THE OPTION OF TAIT TO THE REPAIR OR REPLACEMENT OF THE SOFTWARE OR FIRMWARE OR THE REFUND OF THE PURCHASE PRICE OF THE SOFTWARE OR FIRMWARE.

General

THE LICENSEE CONFIRMS THAT IT SHALL COMPLY WITH THE PROVISIONS OF LAW IN RELATION TO THE SOFTWARE OR FIRMWARE.

Law and Jurisdiction

THIS AGREEMENT SHALL BE SUBJECT TO AND CONSTRUED IN ACCORDANCE WITH NEW ZEALAND LAW AND DISPUTES BETWEEN THE PARTIES CONCERNING THE PROVISIONS HEREOF SHALL BE DETERMINED BY THE NEW ZEALAND COURTS OF LAW. PROVIDED HOWEVER TAIT MAY AT ITS ELECTION BRING PROCEEDINGS FOR BREACH OF THE TERMS HEREOF OR FOR THE ENFORCEMENT OF ANY JUDGEMENT IN RELATION TO A BREACH OF THE TERMS HEREOF IN ANY JURISDICTION TAIT CONSIDERS FIT FOR THE PURPOSE OF ENSURING COMPLIANCE WITH THE TERMS HEREOF OR OBTAINING RELIEF FOR BREACH OF THE TERMS HEREOF.

No Dealings

THE LICENSEE MAY NOT SUBLICENSE, ASSIGN OR TRANSFER THE LICENCE OR THE PROGRAM EXCEPT AS EXPRESSLY PROVIDED IN THIS AGREEMENT. ANY ATTEMPT OTHERWISE TO SUBLICENSE, ASSIGN OR TRANSFER ANY OF THE RIGHTS, DUTIES OR OBLIGATIONS HEREUNDER IS VOID.

No Other Terms

THE LICENSEE ACKNOWLEDGES THAT IT HAS READ THIS AGREEMENT, UNDERSTANDS IT AND AGREES TO BE BOUND BY ITS TERMS AND CONDITIONS. THE LICENSEE FURTHER AGREES THAT SUBJECT ONLY TO ANY EXPRESS WRITTEN TERMS OF AGREEMENT TO THE CONTRARY BETWEEN TAIT AND THE LICENSEE THIS IS THE COMPLETE AND EXCLUSIVE STATEMENT OF THE AGREEMENT BETWEEN IT AND TAIT IN RELATION TO THE SOFTWARE OR FIRMWARE WHICH SUPERSEDES ANY PROPOSAL OR PRIOR AGREEMENT, ORAL OR WRITTEN AND ANY OTHER COMMUNICATIONS BETWEEN THE LICENSEE AND TAIT RELATING TO THE SOFTWARE OR FIRMWARE.

Index

A

- AC millivoltmeter
 - see equipment
- Antenna VSWR (Voltage Standing Wave Ratio) [27](#)
- audio level
 - calibrating [21, 22](#)

B

- balanced input
 - calibrating [21](#)
- balanced output
 - calibrating [21](#)
- band [1](#)
 - entering [4](#)
- base station
 - connecting to [7](#)
 - disconnecting from [7](#)
- bias current
 - required for each power level [27](#)
 - RF detectors [27](#)

C

- calibration test kit
 - see equipment
- calibration test unit (CTU)
 - connecting to computer [6](#)
 - connecting to reciter [6](#)
 - see also equipment
- calibration wizards
 - Balanced Line Calibration Wizard [21](#)
 - Calibrate Fwd/Rev Detector Bias Voltages Wizard [28](#)
 - Calibrate PA Bias Wizard [27](#)
 - Calibrate PA Power Wizard [29](#)
 - Carrier Freq Offset Adjustment Wizard [23, 24](#)
 - FCL Auto Tuning Wizard [16](#)
 - FCL Calibration Wizard [17](#)
 - RSSI Calibration Wizard [19](#)
 - Set Exciter VCO Wizard [14, 15](#)
 - Set Receiver VCO Wizard [9](#)
 - Tune Receiver Front End Wizard [11, 13](#)
 - Unbalanced Line Calibration Wizard [22](#)
 - VCO Band Tuning Wizard [18](#)
- COM port [5](#)
- control voltage [29](#)
- coupler fwd voltage [29](#)

D

- DAC (Digital-to-Analogue Converter)
 - adjusting settings [29](#)
- detector
 - diodes [28](#)
- detectors
 - forward and reverse [27](#)
- directional coupler [28, 28](#)
- driver transistor [27](#)

E

- equipment
 - AC millivoltmeter [20, 21](#)
 - calibration test kit [3](#)
 - calibration test unit (CTU) [10, 13, 20, 21](#)
 - frequency counter [23, 24](#)
 - modulation meter [16, 18](#)
 - power meter [28](#)
 - RF attenuator [16, 18, 23, 24](#)
 - RF signal source [19](#)
 - Torx screwdriver [24](#)
 - tuning tool [9, 10, 12, 14, 15, 16, 18, 24](#)
- exciter
 - adjusting lock band [14](#)
 - calibrating [16, 16, 16, 18](#)
 - component repairs to [16](#)

F

- FCL (Frequency Control Loop)
 - calibrating the modulation [16](#)
- final transistor [27](#)
- forward detector [28](#)
 - calibrating bias voltage [27](#)
- frequency
 - calibrating [23, 24](#)
 - defining center frequency [9](#)
 - defining range of [14](#)
- frequency counter
 - see equipment

G

- gate bias voltage [27](#)

H

- hardware version [1](#)
 - entering [4](#)

L

- lock band
 - definition [9](#)
 - see exciter
 - see receiver
- log files
 - application errors [8](#)
 - commands received and sent [8](#)
- Low Pass Filter (LPF) [28, 28](#)

M

- modulation meter
 - see equipment
- module number [1](#)

O

- operating range
 - see switching range

P

- PA
 - calibrating bias current [27](#)
 - calibrating RF detector bias voltages [27](#)
 - calibrating transmit power [28](#)
 - connecting to [7](#)
 - details [1](#)
 - faulty gain stage [29](#)
 - low RF input power [29](#)
- PCB module [28, 28](#)
- peak deviation
 - measuring [18](#)
- PMU
 - calibrating output voltage [30](#)
- power supply
 - see equipment
- product code [1](#)
 - entering [4](#)

R

- receiver
 - adjusting lock band [9](#)
 - tuning front end helical filters [10, 12](#)
- reciter
 - calibrating [16](#)
 - connecting to [5](#)
 - connecting to in subrack [7](#)
 - details [1](#)
 - off-frequency [23](#)

- tuning the frequency [9](#)
- Reference DAC [28](#)
- resonators
 - see front end helical filters
- reverse detector
 - calibrating bias voltage [27](#)
- RF attenuator [24](#)
 - see equipment
- RF detectors [27](#)
- RF signal source
 - see equipment
- RMS (root means squared)
 - measuring deviation of [17](#)
- RSSI (Received Signal Strength Indicator)
 - tuning receiver [10, 12](#)

S

- serial number [1](#)
 - entering [4](#)
- status bar [2](#)
- switching range
 - adjusting [9](#)
 - definition [9](#)
- system interface [20](#)

T

- TCXO (Temperature Compensated Crystal Oscillator)
 - calibrating [23, 24](#)
- toolbar [2](#)
- troubleshooting [8](#)
 - PA power calibration [29](#)

U

- unbalanced input
 - calibrating [22](#)
- unbalanced output
 - calibrating [22](#)

V

- version
 - of Calibration Kit software [8](#)
- VSWR [27, 29](#)

W

- wizards
 - see calibration wizards